

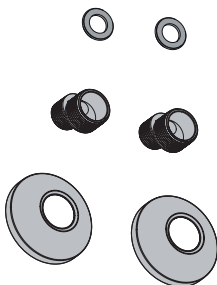

ANDERS

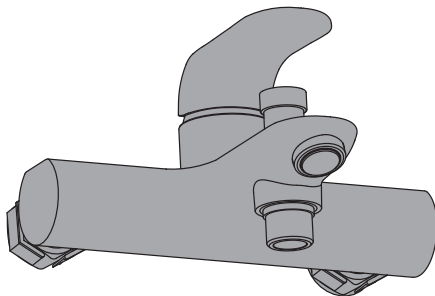

EAN CODE: 3278007184358

FR Notice de Montage -
Utilisation - Entretien

ES Instrucciones de Montaje,
Utilización y Mantenimiento

PT Instruções de Montagem,
Utilização e Manutenção

IT Istruzioni per il Montaggio,
l'Uso e la Manutenzione

EL Εγχειρίδιο συναρμολόγησης,
χρήσης και συντήρησης

PL Instrukcja Montażu,
Użytkowania i Konserwacji

RU Руководство По Сборке
и Эксплуатации

KZ Жинау, пайдалану және
техникалық қызмет
көрсету нұсқаулығы

UA Керівництво По Збірці
і Експлуатації

RO Manual asamblare,
utilizare și întreținere

BR Instruções de Montagem,
Utilização e Manutenção

EN Assembly - Use -
Maintenance Manual

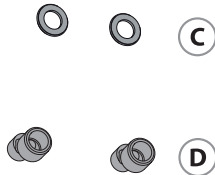
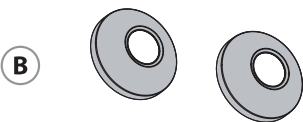
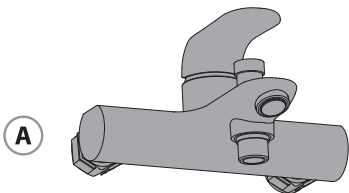
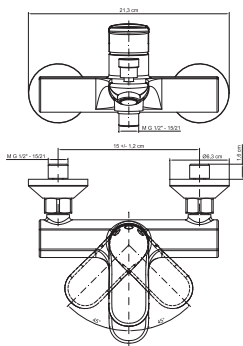
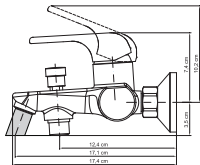



FR: Préparation / ES: Preparación / PT: Preparação / IT: Preparazione / EL: Προετοιμασία /
 PL: Przygotowanie / RU: Подготовка / KZ: Дайындау / UA: Підготування / RO: Pregătire / BR: Preparação /
 EN: Preparation



FR: Montage / ES: Montaje / PT: Montagem / IT: Montaggio / EL: Συναρμολόγηση /
 PL: Montaż / RU: Сборка / KZ: Монтаждау / UA: Збірка / RO: Montaj / BR: Montagem /
 EN: Assembly



FR: Utilisation eau chaude-eau froide/ ES: Utilización agua caliente-agua fría/ PT: Utilização água quente-água fria/
 IT: Uso acqua calda-acqua fredda/ EL: Χρήση ζεστού-κρύου νερού/ PL: Użytkowanie zimnej wody-gorącej wody/
 RU: использование горячей и холодной воды/ KZ: Суық және ыстық суды қолдану/
 UA: використання гарячої - холодної води/ RO: Utilizare apă caldă-apă rece/ BR: Uso de água quente e fria/
 EN: Using hot and cold water



FR: Changement de cartouche/ ES: Cambio de cartucho/ IT: Cambio cartuccia/ PT: Mudança de cartucho/
 EL: Αλλαγή φυσιγγίου/ PL: Wymiana wkładu / RU: Смена картриджа/ KZ: Картриджді ауыстыру/
 UA: Заміна картриджа/ RO: Schimbare cartuş/ BR: Substituição de cartucho/ EN: Replacing the cartridge



FR: Changement de mousseur/ ES: Cambio de aireador/ PT: Mudança de arejador/ IT: Cambio rompigetto/
 EL: Αλλαγή αεράτορα / PL: Wymiana perlatora / RU: Смена аэратора/ KZ: Ауақанықтырғышты ауыстыру/
 UA: Заміна аератора/ RO: Schimbare aerator/ BR: Substituição do aerador/ EN: Replacing the aerator

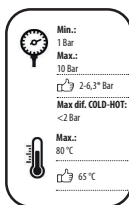

FR:* Si la pression est supérieure à 5 bars, il est nécessaire de rajouter un réducteur de pression / ES:*
 Si la presión es superior a 5 bars, es necesario añadir un reductor de presión. / PT:* Se a pressão for
 superior a 5 bars, será necessário acrescentar um redutor de pressão / IT:* Se la pressione è superiore
 a 5 bar, bisogna aggiungere un riduttore di pressione / EL:* Εάν η πίεση υπερβαίνει τα 5 bars, είναι
 απαραίτητη η προσθήκη μειωτή πίεσης / PL:* Jeśli ciśnienie jest wyższe niż 5 barów, należy dodać reductor
 ciśnienia / RU:* Если давление превышает 5 бар, необходимо добавить редуктор давления / KZ:*
 Егер қысым 5 бардан асатын болса, қысым бәсеңдеткішін қосу қажет / UA:* Якщо тиск перевищує
 5 бар, необхідно додати редуктор тиску / RO:* Dacă presiunea este mai mare de 5 bar, este necesar
 să adăugați un reductor de presiune / BR:* Se a pressão for superior a 5 bar, é necessário adicionar um
 reductor de pressão / EN:* If the pressure is over 5 bars, a pressure reducing valve must be added.



FR: Préparation / ES: Preparación / PT: Preparação / IT: Preparazione / EL: Προετοιμασία /
PL: Przygotowanie / RU: Подготовка / KZ: Дайындау / UA: Підготовка / RO: Pregătire /
BR: Preparação / EN: Preparation

1

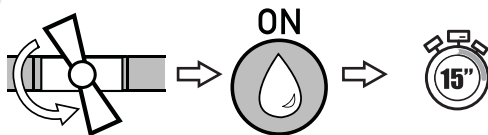

2

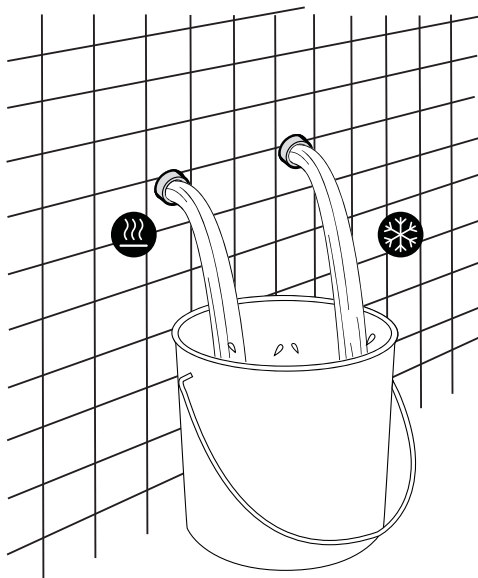

3

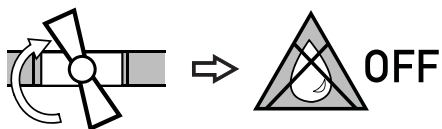

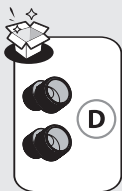

FR: Montage / ES: Montaje / PT: Montagem / IT: Montaggio / EL: Συναρμολόγηση /
PL: Montaż / RU: Сборка / KZ: Монтаждау / UA: Збірка / RO: Montaj / BR: Montagem /
EN: Assembly

1

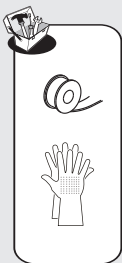
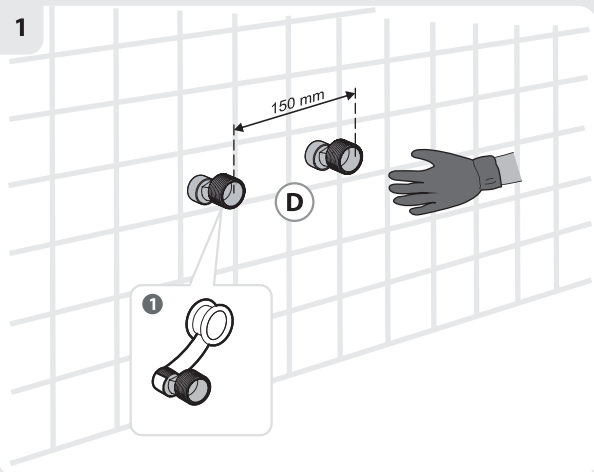

2

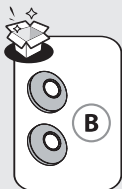
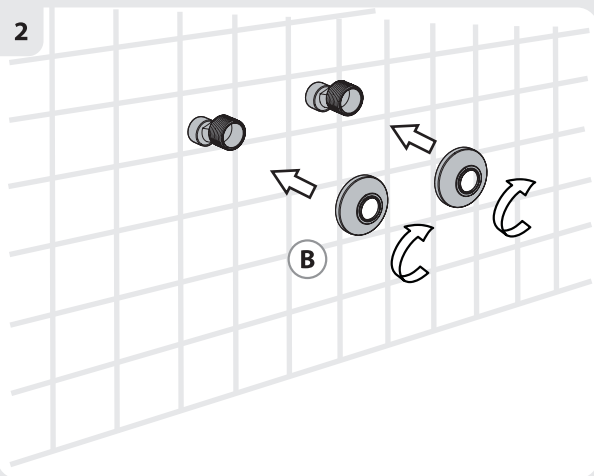

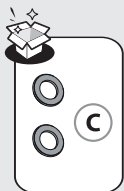

FR: Montage / ES: Montaje / PT: Montagem / IT: Montaggio / EL: Συναρμολόγηση /
PL: Montaż / RU: Сборка / KZ: Монтаж / UA: Збірка / RO: Montaj / BR: Montagem /
EN: Assembly

3

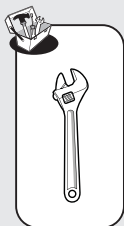
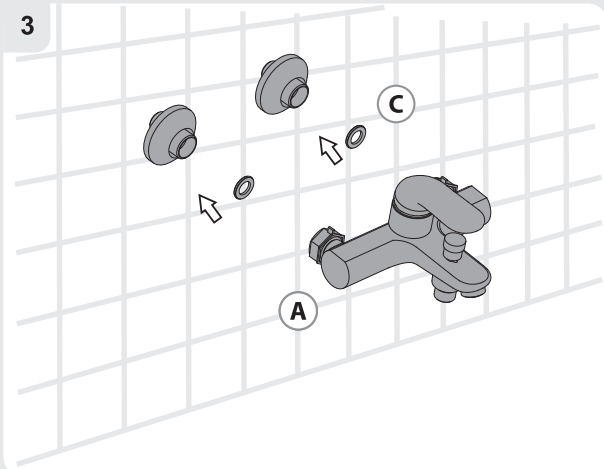

4

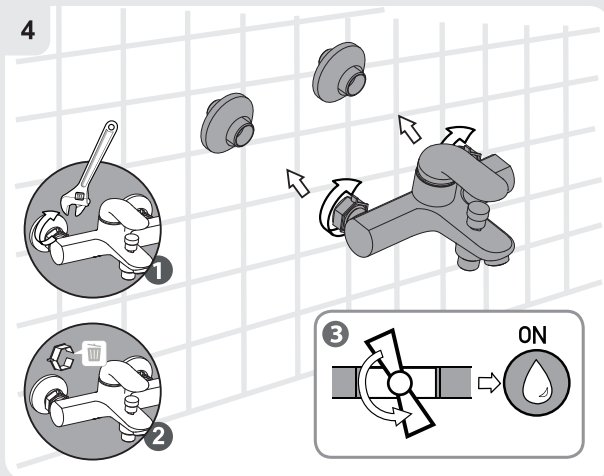



FR: Utilisation eau chaude-eau froide/ ES: Utilización agua caliente-agua fría/ PT: Utilização água quente-água fria/
IT: Uso acqua calda-acqua fredda/ EL: Χρήση ζεστού-κρύου νερού/ PL: Użytkowanie zimnej wody-gorącej wody/
RU: использование горячей и холодной воды/ KZ: Суық және ыстық суды қолдану/
UA: використання гарячої - холодної води/ RO: Utilizare apă caldă-apă rece/ BR: Uso de água quente e fria/
EN: Using hot and cold water

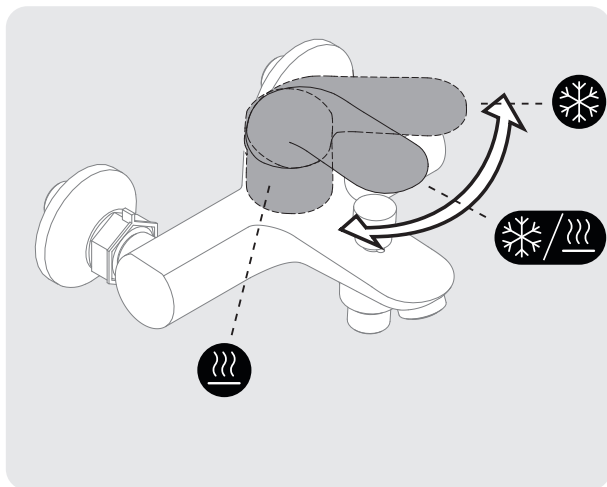
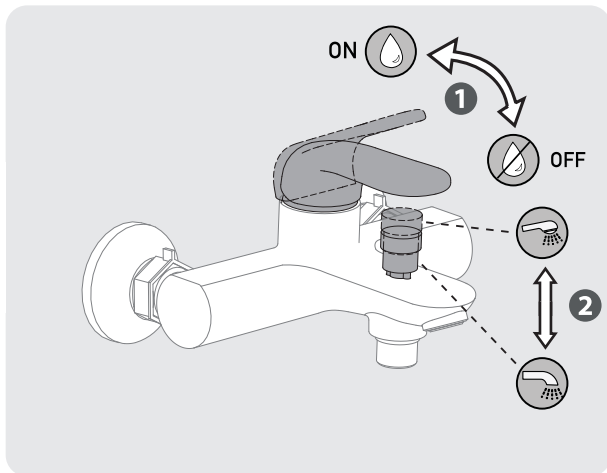

No.	EAN	
	3276007184358	
	Модель поставщика\ Жеткізушінің моделі:	
	18237AD00	
1	0724478CR	1
2	0731952	1
3	0621623	1
4	0661130CR	1
5	0633412	1
6	0802820	1
7	0717516CR	1
8	0622315CR	1
9	06902510000	1
10	40200203301	3
11	0753323CR	1
12	0899009	1
13	0141530	1
14	0752913TC	2
15	0733203CR	2
16	0671287	1
17	0899569	2
18	0761502CR	2
19	0751305CR	2

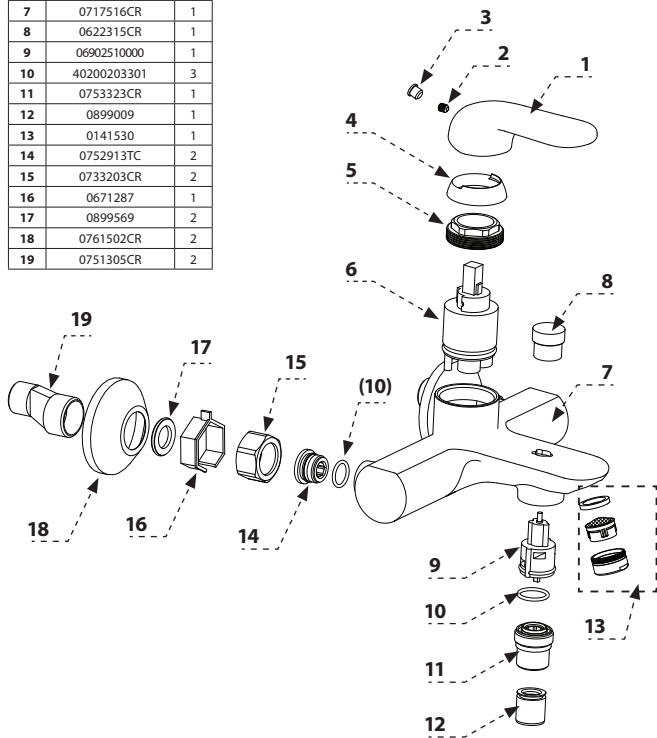



FR: Changement de cartouche/ ES: Cambio de cartucho/ IT: Cambio cartuccia/ PT: Mudança de cartucho/
EL: Αλλαγή φιλτράριου/ PL: Wymiana wkładu / RU: Смена картриджа/ KZ: Картриджді ауыстыру/
UA: Заміна картриджа/ RO: Schimbare cartuş/ BR: Substituição de cartucho/ EN: Replacing the cartridge

1



OFF

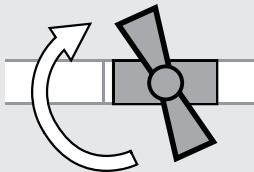

2

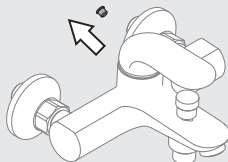

3

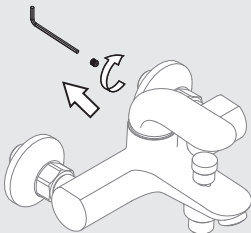

4

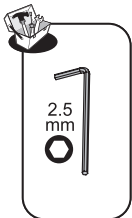
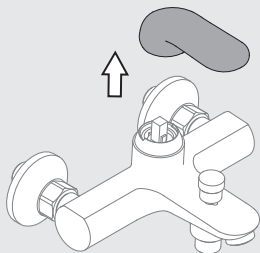

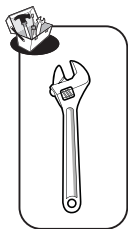

FR: Changement de cartouche/ ES: Cambio de cartucho/ IT: Cambio cartuccia/ PT: Mudança de cartucho/
EL: Αλλαγή φιλτράριου/ PL: Wymiana wkładu / RU: Смена картриджа/ KZ: Картриджді ауыстыру/
UA: Заміна картриджа/ RO: Schimbare cartuş/ BR: Substituição de cartucho/ EN: Replacing the cartridge

5

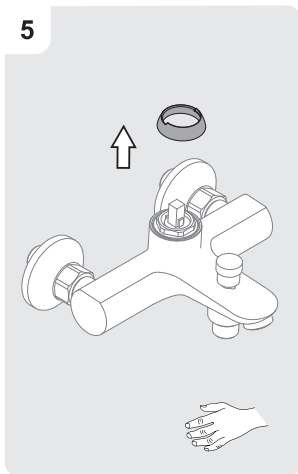

6

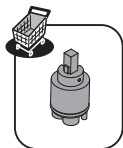
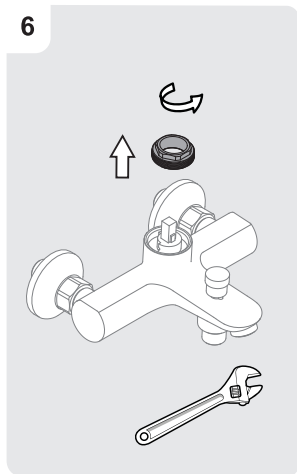

7

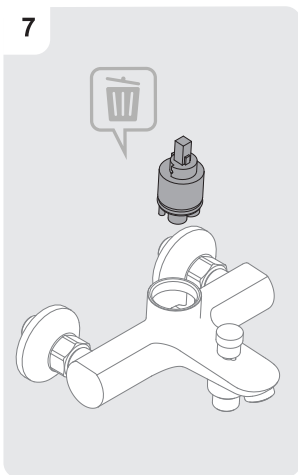

8

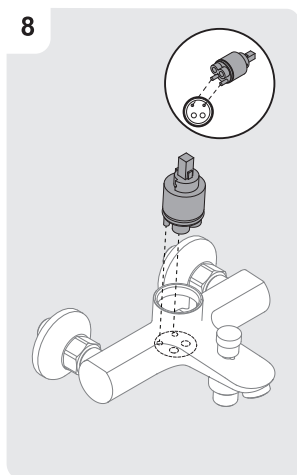

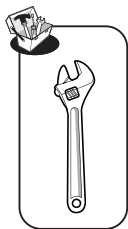

FR: Changement de cartouche/ ES: Cambio de cartucho/ IT: Cambio cartuccia/ PT: Mudança de cartucho/
EL: Αλλαγή φιλτράριου/ PL: Wymiana wkładu / RU: Смена картриджа/ KZ: Картриджді ауыстыру/
UA: Заміна картриджа/ RO: Schimbare cartuş/ BR: Substituição de cartucho/ EN: Replacing the cartridge

9

10-12 N.m

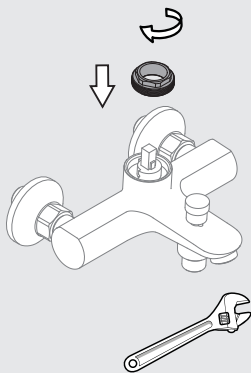

10

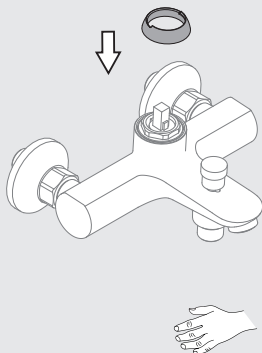

11

2.5
mm

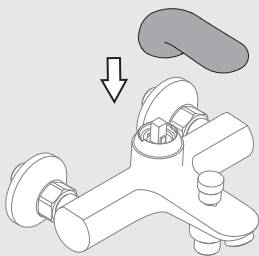

12

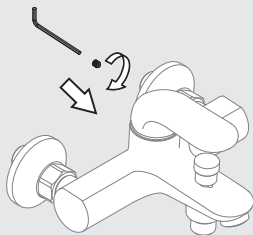



FR: Changement de cartouche/ ES: Cambio de cartucho/ IT: Cambio cartuccia/ PT: Mudança de cartucho/
EL: Αλλαγή φιλτράριου/ PL: Wymiana wkładu / RU: Смена картриджа/ KZ: Картриджді ауыстыру/
UA: Заміна картриджа/ RO: Schimbare cartuş/ BR: Substituição de cartucho/ EN: Replacing the cartridge

13

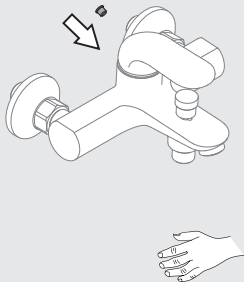

14



ON

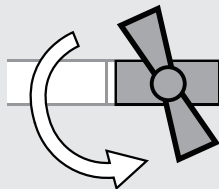

1



OFF

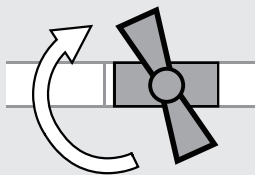

2

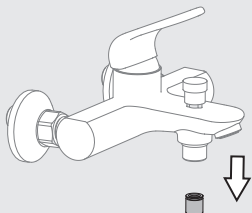



FR: Changement de cartouche/ ES: Cambio de cartucho/ IT: Cambio cartuccia/ PT: Mudança de cartucho/
EL: Αλλαγή φιογγίου/ PL: Wymiana wkładu / RU: Смена картриджа/ KZ: Картриджді ауыстыру/
UA: Заміна картриджа/ RO: Schimbare cartuş/ BR: Substituição de cartucho/ EN: Replacing the cartridge

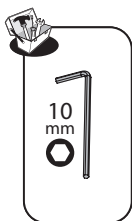

3

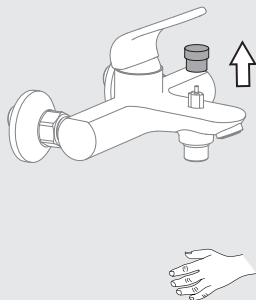

4

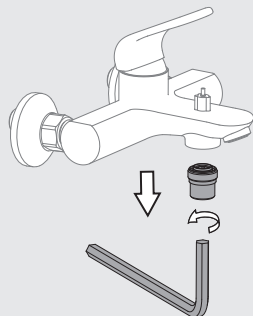

5

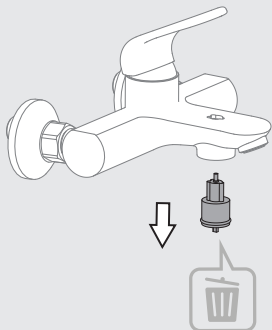

6

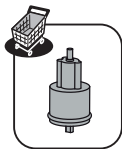
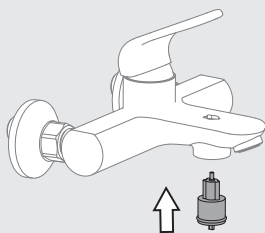



FR: Changement de cartouche/ ES: Cambio de cartucho/ IT: Cambio cartuccia/ PT: Mudança de cartucho/
EL: Αλλαγή φιλτράριου/ PL: Wymiana wkładu / RU: Смена картриджа/ KZ: Картриджді ауыстыру/
UA: Заміна картриджа/ RO: Schimbare cartuş/ BR: Substituição de cartucho/ EN: Replacing the cartridge

7

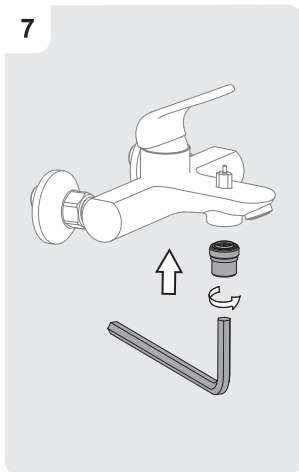

8

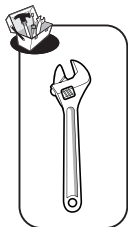
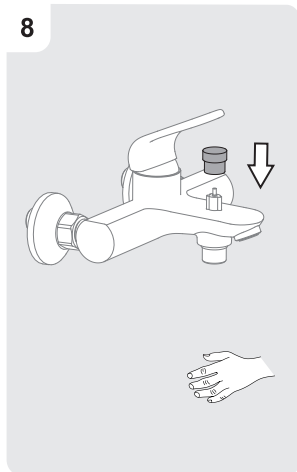

9

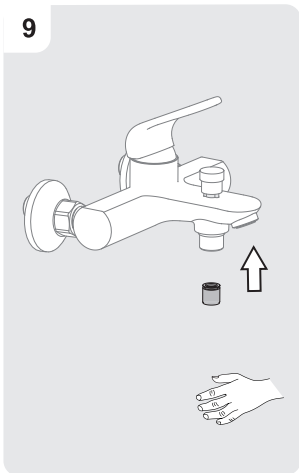

10

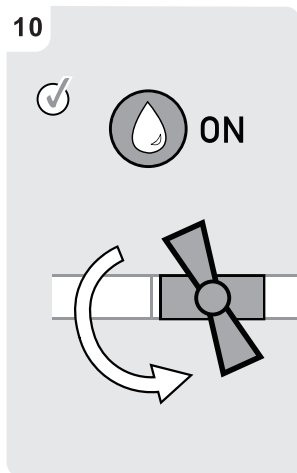

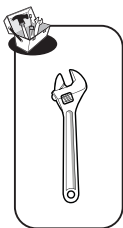

FR: Changement de mousseur/ ES: Cambio de aireador/ PT: Mudança de arejador/ IT: Cambio rompigoetto/
 EL: Αλλαγή αεράτορα / PL: Wymiana perlatora / RU: Смена аэратора/ KZ: Ауақанықтырғышты ауыстыру/
 UA: Заміна аератора/ RO: Schimbare aerator/ BR: Substituição do aerador/ EN: Replacing the aerator

1

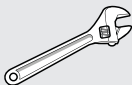
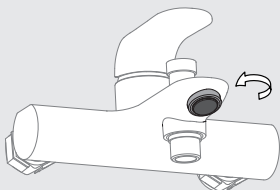

2

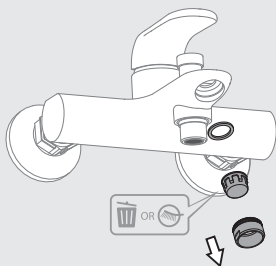

- | | | |
|--------------|----------------|-------------|
| FR Nettoyage | EL Καθαρισμός | UA Очищення |
| ES Limpieza | PL Czyszczenie | RO Curățare |
| PT Limpeza | RU Чистка | BR Limpeza |
| PL Pulzacja | KZ тазарту | EN Cleaning |

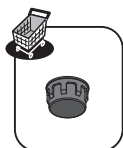

3

- | | | | |
|-------------|----------|-------------|------------|
| FR Vinaigre | IT Aceto | RU Уксус | RO Oțet |
| ES Vinagre | EL Εξόδι | KZ Сірке су | BR Vinagre |
| PT Vinagre | PL Ocet | UA Оцет | EN Vinegar |

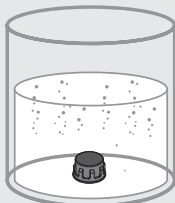

4

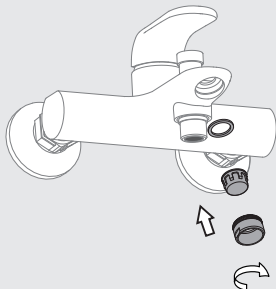



Eau claire / Aqua limpia / Água limpa / Acqua pulita / Καθαρό νερό / Czysta woda / Чистая вода / Água limpa /
Чиста вода / Ara curata / таза су / Clean water



Sans solvant / Sin disolvente / Sem solventes / Senza solventi / Χωρίς διαλυτικά / Bez rozpuszczalnika / Без растворителя /
Sem solventes/ Без розчинника / Fara solvent / еріткішсіз/ Solvent-free

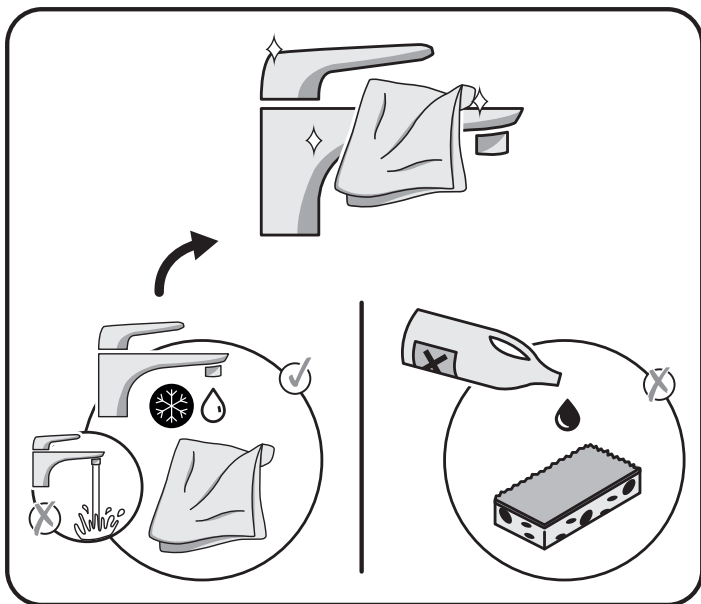



- FR** Attestation de conformité sanitaire
- ES** Certificado de conformidad sanitaria.
- PT** Atestado de conformidade sanitária.
- IT** certificato di conformità sanitaria.
- EL** Βεβαίωση υγειονομικής συμμόρφωσης.
- PL** Certyfikat zgodności sanitarnej.
- RU** Декларация о соответствии санитарным нормам
- KZ** Санитарлық талаптарға сәйкестік декларациясы
- UA** Декларація про відповідність санітарним нормам
- RO** Atestat de conformitate sanitară
- BR** Certificado de conformidade sanitária.
- EN** Declaration of sanitary conformity.



* Garantie 5 ans / 5 años de garantía / Garantia de 5 anos / Garanzia 5 Anni / Εγγύηση 5 ετών /
Gwarancja 5-letnia / Гарантия 5 года / Кепілдік 5 жыл / Гарантія 5 років / Garantie 5 ani /
5-year guarantee



2020

FR ADEO Services - 135 Rue Sadi Carnot - CS 00001
59790 RONCHIN - France

UA ТОВ «Леруа Мерлен Україна»,
вул. Полярна 17а, м. Київ 04201, Україна

RU ООО ЛЕРУА МЕРЛЕН ВОСТОК, 141031, Московская
область, г. Мытищи, Осташковское шоссе, д.1, РОССИЯ

BR Importado e distribuído por LEROY MERLIN
C/À BRASILEIRA DE BRICOLAGEM
Rua Domingos Galleteri Blotta, 315 - Interlagos - CEP
04455-360 São Paulo - SP - Brazil CNPJ: 01.438.784/0001-05
CALM (Central de Atendimento Leroy Merlin) -40.20.5376 (capitals)
e 0800.0205376 (demais regiões)

SA Imported by Adeo South Africa (PTY) LTD T/A Leroy Merlin
Leroy Merlin Greenstone Store - Corner Blackrock Street
and Stoneridge Drive, Greenstone Park Ext 2,
Edenvale, 1610 - Johannesburg, Gauteng, South Africa

KZ «Леруа Мерлен Қазақстан» ЖШС Қазақстан
Республикасы, 050000, Алматы қ., Қонаев
көшесі, 77, «ParkView» БО, ӨК, 07 сф.

BY Поставщик/импортер/организация, принимающая
претензии по качеству товара в Республике Беларусь:
ООО «Леруа Мерлен Бел», 220020, Республика Беларусь,
г. Минск, пр-т Победителей, д. 100, каб. 503



HI417P